



STERIAL II
Premium Air Purifier

USER MANUAL





STERIAL II

Premium Air Purifier

CONTENTS

1. INTRODUCTION	2
Overview	2
How does the device operate?	3
How is it installed?	3
Where can it be installed?	3
Technical features	4
2. GETTING STARTED	5
Warning	6
Device characteristics	7
Initial settings & navigation on the main menu	8
Access to the device	9
About filter replacement	10
About lamp replacement	11
3. USE OF THE DEVICE	13
Cleaning instructions for the device	13
Safety Instructions	14
Warranty, terms & conditions	16
4. TROUBLESHOOTING & SUPPORT	17

1. INTRODUCTION

This User Manual (UM) provides all the necessary information for the proper operation, use and maintenance of **STERIAL** air purifier device.

STERIAL has been designed for the purification of the indoor air from microbes, viruses and other damaging pollutants. In addition, it is specifically designed for the air purification against the coronavirus.

STERIAL air purifier has the following certificates and attestations, by accredited certification bodies:

University of Patras, Chemistry Department	Attestation of non-toxicity of filters' materials
University of Patras, Medicine Department - Hygiene Laboratory*	Certification of non-toxicity for the filters and the material they are made of
University of Patras, Medicine Department - Hygiene Laboratory*	Attestation - Certification regarding the efficiency of the device against Viruses (including SARS-CoV-2) and Microbes
University of Patras, Medicine Department - Hygiene Laboratory*	Efficiency Attestation - Certification regarding the particular matter in the chamber of the device
National Center of Scientific Research "Demokritos"	Control Attestation regarding the non - escape of UV-A/B/C radiation
National Center of Scientific Research "Demokritos"	Analysis Report about the decrease of microparticles concentration
National Center of Scientific Research "Demokritos"	Analysis Report about ozone emission
Alfa Measurements*	Measurement Report of dust emissions
EMC HELLAS	Declaration of Conformity (CE)

*The laboratory is level 2 and is accredited according to ELOT EN ISO/IEC 17025 by the Hellenic Accreditation System (ESYD).

Overview

STERIAL device uses two methods of air purification:

- with the use of UV-C radiation lamps in 254nm
- with filters of polymer material, which trap and separate the pathogenic microorganisms.

The device achieves total neutralization of viruses and microbes, as it operates by recycling the air and channeling it through the filters and the radiation of the UV-C lamps.

How does the device operate?

At the device's inlet there is a first arrangement of filters comprising 3 different filters: a) PPU20 class G3, b) Carbon Filter, c) ALU mesh Filter. These essentially function as pre-filters for the air inside the device and are impregnated with patented organic polymers.

After the first stage, the air makes its way inside, where, after strong UV-C radiation, it continues to get purified as it goes towards the exit, entering the second array of three different filters: a) ALU mesh Filter, b) Carbon Filter, c) HEPA 14 Filter. These particular filters contain and eliminate all the remaining residues from the previous processes, releasing the air once again into the environment, now healthy and free - to an extremely high degree - from viruses, bacteria, microbes and micro-organisms in general.

How is it installed?

The device is installed vertically in the place chosen. Once plugged in, the device can start operating without any further adjustments.

Where can it be installed?

To **STERIAL II Premium Air Purifier** can be installed in Healthcare and Professional environments, as well as Cultural Event halls, where large numbers of people gather and the danger of transmitting diseases by air is increased.

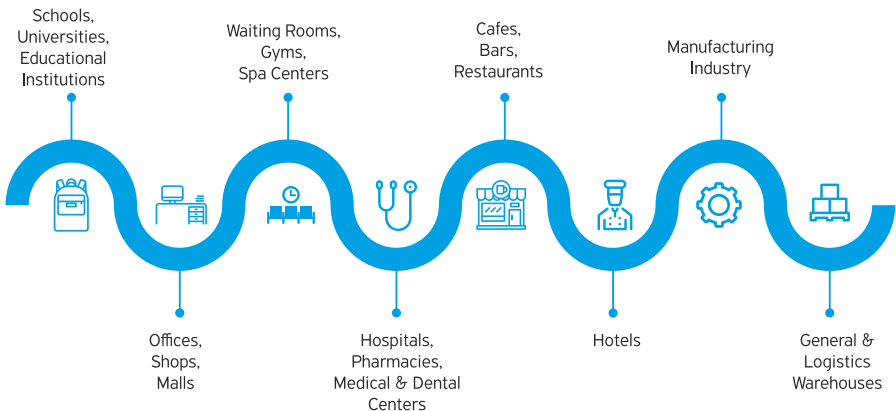

Technical features



- 1 Air intake.
- 2 Power deactivation switch in case of violation, to protect from UV-C radiation.
- 3 Array of three (3) different active filters, impregnated with patented organic polymers. These don't only filter the microbes but also destroy and eliminate viruses and microbes. Environmentally friendly.
- 4 Silent compression fans of two (2) and four (4) speeds (Sterial I & II respectively), high performance (STERIAL I 35db – 65db at 450m³/h and STERIAL II 35db – 65db at 450m³/h).
- 5 Touch screen – Device control panel and basic air data report.
- 6 Radiation chamber with double aluminium walls, for total protection against the UV-C radiation escape.
- 7 UV-C high power lamps (3 X 40W).
- 8 Reflective surface for multiplication of UV-C radiation power.
- 9 Second array of three (3) different filters, with HEPA 14 stage.
- 10 Electric power switch, with safety fuse.
- 11 Fresh air outlet (without trace elements and microbial micro-organisms).

2. GETTING STARTED

In order for STERIAL air purifier to be in operation, the one end of the power wire (IEC C 13) must be placed into the special socket of the device (IEC C 14 on the back and lower side) and the other end into the power socket. After the user is sure of the connection, sets the main operation switch at the back of the device to the "ON" position.

The device starts operating.

The user has the option to choose between five different levels of air recycling, as well as the brightness levels of the side light (LED).

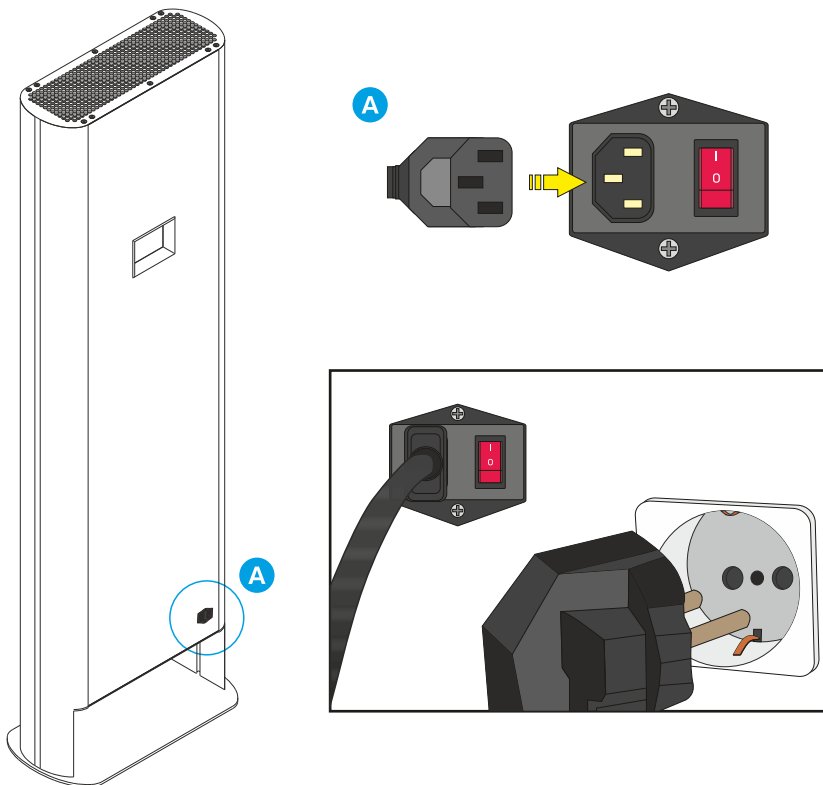

Note: The “Turbo” mode of the airflow speed has a time limit of five (5) minutes. After five minutes the device automatically returns to level 4 operation.

(A) STERIAL I & II PREMIUM Air Purifier and (b) STERIAL III Professional Air Purifier devices have the capability to recycle and clean (a) 450 and (b) 900 cubic meters of air per hour. The speed selection of airflow is depending on the dimensions of the space and the time frame in which we want to achieve air purification.

Example of STERIAL II operation: for a space of 50 sq.m. (3m. height) and desirable air purification at 99.5% within 20 minutes.

Method 1: Without “Turbo” mode

Operation level 3 is selected for 20 minutes.

After 20 minutes the air has been cleaned.

Method 2: With “Turbo” mode

“Turbo” operation level is selected.

After 5 minutes the device automatically switches to level 4.

The device keeps operating for 10 more minutes (at level 4).

After 15 minutes (10 minutes at level 4 and 5 minutes in “Turbo” mode) the air has been cleaned.

Then, the user selects level 1 or 2 to maintain the result for as long as he/she wishes.

Note: The cleaning time may vary as it depends on several factors (such as air quality, degree of contamination, total area and arrangement of the space, height of the space, possible creation of air streams, number of users in the space, number of persons entering/leaving the space). The user chooses to adjust the operation mode of the device, in accordance with the special conditions that occur in his/her space.

Warning

The device has an automatic malfunction-detection system . If the device shows a red “X” indication on the screen, please read chapter 4 “Troubleshooting & Support”.

Device characteristics



Dimensions (Height x Length x Width)
143cm x 42cm x 15cm



Weight (Kg)
37 kg



Power
300 W



UV Lamp Power
3 x 40W



Noise
35db – 65db



Filter Life
max 2.000 h



Screen
Color 3.5" TFT



Mounting Base
Fixed on the floor or trolley



Maximum operation hours
of UVC lamps
max 10.000 h



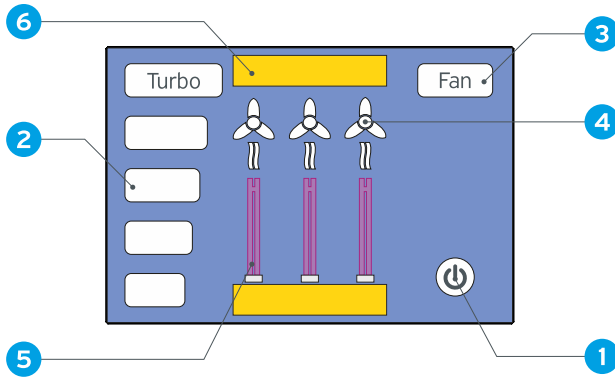

- | | |
|------------------------------------|--|
| 1. ON/OFF indication | 4. Indication of motor operation |
| 2. Option of airflow gradation/LED | 5. Indication of UV-C lamps' operation |
| 3. Option of switching Fan/LED | 6. Indication of filter condition |

Initial settings & navigation on the main menu

STERIAL air purification device does not need any initial adjustment.

The user just decides the operating speed of the fans, selecting between five escalating levels according to his/her preference. (2) Furthermore, by pressing the key with the “LED” indication (3), the device uses the same levels in order to adjust the brightness of the side lighting. After a few seconds from the “LED” brightness selection, the menu returns automatically to the selection of the fans' operating speed.

By pressing the indication “ON-OFF” (1) on the right lower level, the device switches off. By pressing anywhere on the screen, the device starts operating again.

Access to the device

The access on the interior of STERIAL air purification device should preferably be conducted by specialized personnel, using the appropriate tools and materials:

1. Angled screwdriver Allen No 3 & No 4 (included in the package)
2. Shear cutter (for the lamp replacement)
3. 0,3mm wire, galvanized or stainless steel (for the lamp replacement)
4. Disposable gloves (for the lamp replacement)

The device must be disconnected from the electric power. Firstly, we press the power switch on the back part of the device, in order for it to be in the "OFF" position and then we completely remove the power cord. Then, we can proceed with the replacement of the filters or/and the lamps.



About filter replacement

The filter-replacement can be done by anyone, without any protection measures, as they are sanitary and environmentally neutral.

The Allen-type screws must be removed from the upper side of the device, so that the protective grid can be removed, as well as the respective screws on the lower side of the device. Then, the filters are being removed and replaced by the new ones.

Important: The used filters are biologically neutral, do not require a special treatment and can be disposed in a common bin. They are not recyclable.

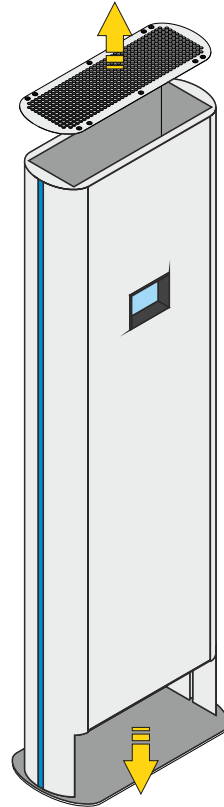

Pay attention to the inlet and output filters, which must be placed in the right places (inlet filter-output filter). The airflow intake in the device is taking place on the lower side. Beware of the filter arrows that indicate the airflow.

About lamp replacement

We follow the same process as with the filter replacement. This particular process can be simplified, without the need of a workbench and we can remove the cap, by unscrewing only the three (3) middle-low screws instead of all of them, sliding the front cap upwards and catching it from the lower side until the lamps appear.

We use a shear cutter to cut the wire with which they are safely tied. We slightly pull the lamp to our side - to the side of the support base - in order for it to be disconnected from the adapter. Similarly, we connect the new lamp to its power adapter, pulling it slightly, after we are sure that is hooked. Then, we pull slightly the other side of the lamp to the holding hook and we tie the lamp with the short wire.

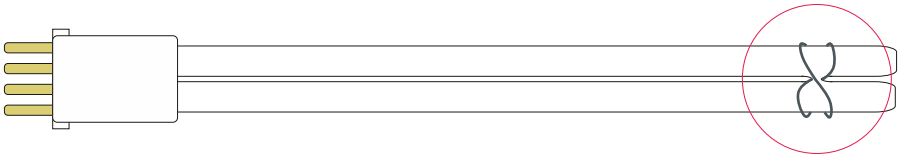

Important: To install the new lamps, it is required to use disposable gloves, because the natural oils that the human skin produces can affect in a negative way the lamp's efficiency or even destroy it (the lamp could be burned out).

Attention: For the disposal of the used UV-C lamps, there must be followed the same process as with the common fluorescent lamps. So, they must be disposed in the special recycle bins for lamps, with caution in order not to break.



The connection with the short wire must be done under the “H” of the lamp in order to bind it. We slightly and carefully tighten, so that we do not break the lamp. Due to its constant exposure to UV-C radiation, the binding of the lamps must be done with wire and not with another material that is polymerized (e.g. Tyre Up/Cable Ties).

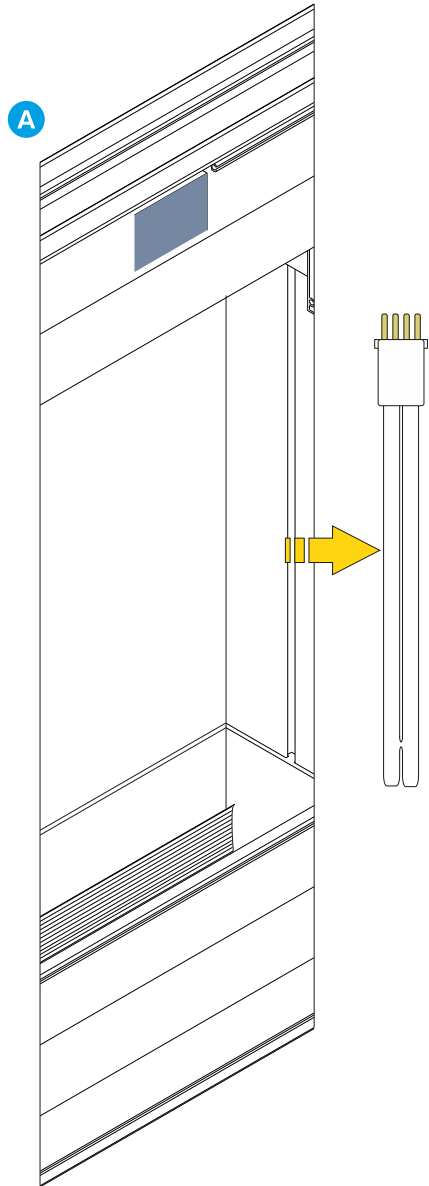
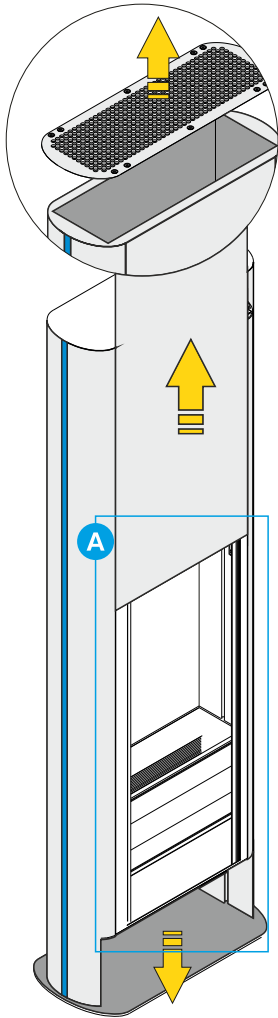

3. USE OF THE DEVICE

STERIAL is suitable for installation in any enclosed space.

It is ideal for both domestic and professional use and anywhere there is a large number of people gathering. It is also an ideal solution for sanitary facilities, as it can effectively neutralize the biggest amount of viruses and microbes.

Depending on the square meters and the device type - STERIAL II or STERIAL III, the time period during which the air is completely purified inside the device differs.

Cleaning instructions for the device

Turn off the device and remove the power cord.

The external surfaces of the device can be cleaned up with a clean and dry cloth.

The use of cleaners-detergents is prohibited, as it can potentially cause:

- Discoloration of the external aluminium casing
- Malfunction or destruction of electronics (e.g. indications' screen)
- Tampering or destruction of the cleaning filters

Safety Instructions

The following safety instructions are crucial for the correct and proper use of the device:

- Read these instructions carefully before the installation and use of the device. Retain the instruction manual for future use or for subsequent owners.
- Check the device for any damage after unpacking it. Do not connect the device if it has been damaged during transport.
- Infants, children and persons of vulnerable groups are not allowed to touch or clean the device, even if they are supervised or so instructed by a person responsible for their safety. It is also forbidden for children to play on or around the device and they must maintain a safe distance from its power cable.
- Using the device for any purpose other than the one intended is dangerous.

In case of non-meticulous use of the device there is:

1. Risk of fire or electrocution

Using the device for any reason other than the one it has been constructed for, is dangerous and may cause fire or electrocution.



- The following are prohibited: pouring water or any other liquid on the device, placing objects on the device, hugging the device and any mistreatment of the device.
- The device is characterized as high voltage and therefore any movement of its housing is prohibited. A defective device can cause electrocution, so it must be carefully unpacked by the buyer.
- It is noted that the insulation cable must not come into contact with the hot spots of the device and that the device must be placed indoors, where no intense heat or humidity is detected. The device must be exposed to a minimum of humid environments.

- Spontaneous repair of the device's electrical parts may cause electrocution. Repairs and replacements of damaged power cables must be performed by a trained technician. If the device is defective, turn off the main power supply at the back of the device and unplug the power cable.
- Under no circumstances should high pressure cleaning devices or steam cleaners be used, as they may result in electrocution.

2. Risk of exposure to ultraviolet radiation

The device has ultraviolet lamps and is designed so that, during its normal operation, the ultraviolet radiation cannot escape. In normal operation conditions, the use of the device is totally safe. The exposure to UVC radiation can cause skin irritation or burn and inflammation of the cornea or photokeratitis. For this reason:



- It is forbidden to remove the device's external casing while it is operating.
- It is forbidden to start operating the device, if all the external parts have not been placed in their correct position.
- It is forbidden – in any way or circumstance – to modify the device's operation or design, that will lead to the exposure of the users to ultraviolet radiation.

For safety reasons, please follow the instructions below:

1. The power cable should not be replaced during device's operation.
2. The power socket should be easily accessible, in order for the device to be easily disconnected from power supply.

Warranty, terms & conditions

- The device meets high quality standards concerning both materials and construction.
- The warranty is valid for **twenty-four (24) months** from the date of purchase. From the warranty are excluded: the consumables, meaning the filters and the UV-C lamps.
- During the warranty period, any defective materials can be repaired or replaced, provided it is proved they cause damage to the device. The coverage of labour costs or costs pertaining to travel or packaging and transport is excluded.
- Replacement or repair during the warranty period does not result in an extension of the warranty period.

The warranty does not apply in the following cases:

- When the repair is performed by non-authorized personnel or/and by using non-genuine spare parts.
- When caused damages or defects are due to negligent maintenance or misuse.
- When the consumables that are used are not compatible or approved by the manufacturer.

GLM Hellas disclaims any liability in case of malfunctions of the device due to external factors, such as electric power change, strong electromagnetic fields, or other related interference.

Materials and spare parts that are defective must be replaced exclusively by the seller from whom they were purchased.

4. TROUBLESHOOTING & SUPPORT

If any of the device's fans or lamps appears on the screen with a red "X" indication, this means it is out of order.

The maximum useful operating time of STERIAL air purifier's filters is: 2.000 operating hours. The filters may need to be replaced earlier, depending on the air quality of the space in which the device operates.

After this time frame, the filters appear on the screen with a red "X" and must be replaced.

The maximum useful operating time of STERIAL air purifier's UV-C lamps is: 10.000 operating hours. The lamps may need to be replaced sooner.

After this time frame, the lamps appear on the screen with a red "X" and must be replaced.



Company	Telephone	Email
GLM Hellas	+30 23160 22400	sterial@glmhellas.com

The logo for GLM features the letters 'GLM' in a bold, white, sans-serif font. The letter 'G' is partially filled with a bright yellow color, creating a distinctive visual element.

GLM HELLAS S.A.

Kilkis Industrial Area, Block 11
P.O. Box 19, GR 61100 Kilkis
T +30 23 160 22400
sterial@glmhellas.com
www.sterial.com.gr